



ENZFELDER GmbH

Power transmission
and
lifting engineering

**Spindle gear cubic
Type BG**

History

1969 Mr. Enzfelder established a job shop in Vienna. Equipped with some machinery, the Enzfelder Company manufactured machine parts according to drawings.

Within one year the number of employees rose to 3. The Enzfelder company started manufacturing threaded spindles and nuts according to drawings. Then the range of manufacturing was enlarged by toothed wheels, screw wheels and endless screws according to drawings.

1974 The company including the complete manufacture was relocated to Enzesfeld.

1975 The manufacture of spindle gears was launched. The company's experience in the manufacture of trapezoid-threaded spindles, nuts, worm gear pairs and casings was a valuable basis for the construction. After many tests, the serial production of spindle gears was launched one year later. The result was a product characterized by a first-rate price-performance ratio. The product was distributed by dealers all over Europe.

1981 The planning and construction of small hydropower plants was launched to replace diesel generators. Environmental protection was not really a topic at that time, however, and the production was stopped in 1986.

1989 The Enzfelder GesmbH company replaced the Franz Enzfelder Company.

1990 Scissor-type lifting platforms and cable winches were added to the delivery program.

1991 Resilient spacer shafts were tested and added to the production range. At the same time, the telescopic spindle gear was developed. A patent for this principle was applied for and issued.

1993 The sale of spindle gears under their own name was launched and presented for the first time at the Hannover industrial fair. We have been approached with a variety of tasks and have provided solutions according to the customers' needs ever since.

1994 In cooperation with our customers we produced the first bevel gears to specification.

1995 Spindle bearing arrangements were designed and included in the standard program.

1996 The Enzfelder company produced planet gear to specification for the first time.

1998-1999 The standard programs were enlarged. Additionally, bevel gears are manufactured in a standard design.

2000 The development of electric cylinders in standard design for very high loads (5-1000kN) was started. At the same time the telescopic spindle gears were refined to save the customer the guiding and locking devices. Since that time we have been able to offer telescopic cylinders, too.

2001 The development of electric cylinders was completed, and these cylinders were added to the standard program.

At the same time the development and fabrication of cubic spindle gears for lifting loads between 2.5 and 150kN was started. These gears were added to the standard program as well.

2002 were extended and optimized the series of the electric cylinders. Further we provide an electronic 2D-3D product catalogue of the spindle gears, it makes it possible to integrate our products into your system.

2002-2003 We putted our new assembling and packaging hall, beside the manufacturing hall, in operation

2003 We increased our machinery by buying a CNC machine tool with 7 axes, brand AXA. That new CNC machine allows a precise machining of the screw jack housings in only two clamping.

2003-2004 The engineering started to use new 3-D CAD software, Solid Edge. That software enables our customers to integrate easily our drawings.

2004 We opened a sales office in France.

2004-2005 We started to design the high performance screw jacks HSG and we created a range of 10 different sizes.

2005 First participation to an exhibition in France: INDUSTRIE 2005 at Lyon.

2005-2006 We started to design a new range of telescopic screw jacks TSGLR. Today, these new telescopic screw jacks, with a more compact design, are used in the stage industry, in the aircraft industry, on train lifting equipments and in machine building.

2008 We replaced the tread grinding machine by a new CNC thread grinding machine, brand Mikromat.

In the past years we solved problems of motive power engineering and lifting for our customers. We searched and found the optimal solution for each case and manufactured at the best possible price/performance ratio.

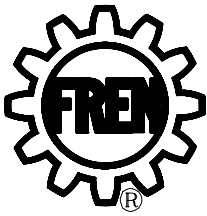

Content of Catalog

ENZFELDER GMBH
Power transmission- and
lifting engineering
 Eichengasse 36
 A-2551 Enzesfeld-Lindabrunn
 Tel.: ++43 (0) 2256 81287-0
 Fax: ++43 (0) 2256 81287-95
 E-Mail: office@enzfelder.at
 Internet: www.enzfelder.at

	Page
Selection of spindle gears	3
Survey of construction modes with example for ordering	4
Spindle gear basic type	5
Spindle gear traveling nut type	6
Flange plate, spindle nose 4, pivoting head	7
Fork head, fastening strips, cardan plate	8
Spindlegear with elastic coupling and motor, hand wheels, crank handles	9
Elastic coupling, elastic propeller shaft	10
Limit stop, safety nut for traveling nut type, pedestal bearing	11
Mounting and maintenance instructions	12
Critical compressive force	13
Lateral forces on spindle, spindle torque	14
Driving torque, required speed of the driving motor, driving motor	15
Driving torque - of a spindle gear, - of spindle elevating equipment	16
Questionnaire	17
Examples for arrangements	18

Here I should be! If you need me and I are not there, THEY can request me free of charge at company Enzfelder!

Type BG

CAD-Files

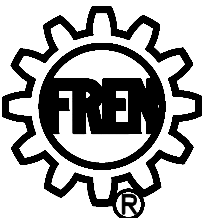
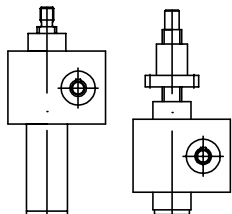
Enzfelder GmbH

Eichengasse 36
 A-2551 Enzesfeld
 Tel.: +43 (0) 2256 81287-0
 Fax.: +43 (0) 2256 81287 95
 e-mail.: office@enzfelder.at
 www.enzfelder.at

01 - 2003

Copyright 2003 Enzfelder GmbH.
 All rights reserved

Darstellung unverbindlich
 Massänderung vorbehalten

Enzfelder GmbH übernimmt keine Haftung für Schäden, die durch Benutzung der CD-Rom entstehen, sei es insbesondere durch Vermengung mit anderen CD-Rom's, die als Folge von Schäden mit der Benutzung der CD-Rom in Verbindung stehen.

Representation not obligatory
 Subject to measurement changes

Enzfelder GmbH is not liable for damages arising from the use of CD-ROM. Particularly not for any personal injuries, material damages and damages to property that follow from the use of the CD-ROM or are in conjunction with it.

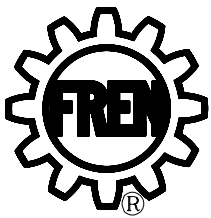

Selection of spindle gears

ENZFELDER GMBH
Power transmission- and
lifting engineering

Eichengasse 36
 A-2551 Enzesfeld-Lindabrunn
 Tel.: ++43 (0) 2256 81287-0
 Fax: ++43 (0) 2256 81287-95
 E-Mail: office@enzfelder.at
 Internet: www.enzfelder.at

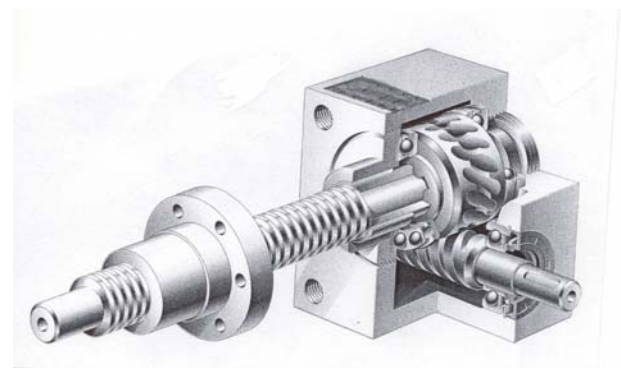
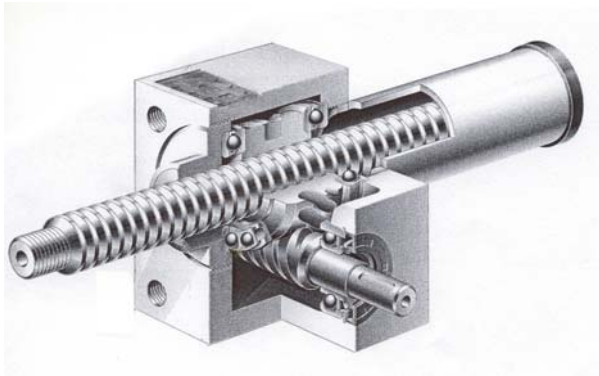

For the correct selection of spindle gears the following data are of decisive importance:

- | | |
|--|----------------------|
| 1.) load | [kN] |
| 2.) lifting speed | [m/min] |
| 3.) operating cycle | [%/10min] [%/hour] |
| 4.) spindle length (buckling) | [mm] |
| 5.) tensile- or pressure load | [kN] |
| 6.) ambient temperature | [°C] |
| 7.) fitting length (please indicate when ordering) | [mm] |
| 8.) critical speed of the spindle | [min ⁻¹] |

If you use the questionnaire on page 17 please provide the data available.

How to proceed in the selection: on the basis of the desired load data (in kN) a suitable type of gear is selected from the preselection table below.

Sizes	rated power kN	rated power in kN by ball bearing spindle	gearbox material	size of spindle	size of ball bearing spindle	gear reduction		length of stroke per rotation in mm		length of stroke per rotation in mm by ball bearing spindle	efficiency in %		efficiency in % by ball bearing spindle	max. driving power duty cycle 20%/h in kW	max. driving power duty cycle 10%/h in kW	weight in kg exct. lifting element	weight in kg per 100mm stroke
						H	L	H	L		H	L					
BG 2,5	2,5	---	AL-Leg.	Tr 14x4	-----	4:1	16:1	1,0	0,25	----	34	24	---	0,18	0,25	0,6	0,1
BG 5	5	5		Tr 18x4	1605	4:1	16:1	1,0	0,25	1,25	30	23	57	0,3	0,42	1,2	0,35
BG 10	10	10		Tr 20x4	2005	4:1	16:1	1,0	0,25	1,25	28	21	56	0,5	0,7	2,1	0,45
BG 25	25	12,5	GG	Tr 30x6	2505	6:1	24:1	1,0	0,25	0,83	27	19	55	1,2	1,7	6,0	0,7
BG 50	50	22/42		Tr 40x7	4005/10	7:1	28:1	1,0	0,25	0,71/1,43	25	18	53/56	2,3	3,2	17	1,2
BG 100	100	65	GGG	Tr 55x9	5010	9:1	36:1	1,0	0,25	1,1	19	14	47	5,1	7,1	32	2,0
BG 150	150	---		Tr 60x9	-----	9:1	36:1	1,0	0,25	----	19	14	---	7,2	10	41	2,4

Read off the dimensioned sketch and the performance table on the corresponding page of the catalog:

- whether the dimensions of gear and spindle fit into your system.
- which gear reduction must be selected for the desired lifting speed (for higher lifting speeds the use of a double-thread spindle may be necessary).
- whether the power required for the desired lifting speed is admissible.
- whether under pressure load the critical buckling force is not exceeded.
- whether the critical revolutions/min of the spindle are not exceeded.
- If one of these requirements cannot be met the type next in size must be chosen.
- If point 6 is not sufficient, choose one of the types next in size or ask for special types (questionnaire see page 17)

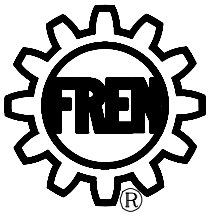

Survey of construction modes with exemple for ordering

ENZFELDER GMBH
 Power transmission- and
 lifting engineering

Eichengasse 36
 A-2551 Enzesfeld-Lindabrunn
 Tel.: ++43 (0) 2256 81287-0
 Fax: ++43 (0) 2256 81287-95
 E-Mail: office@enzfelder.at
 Internet: www.enzfelder.at

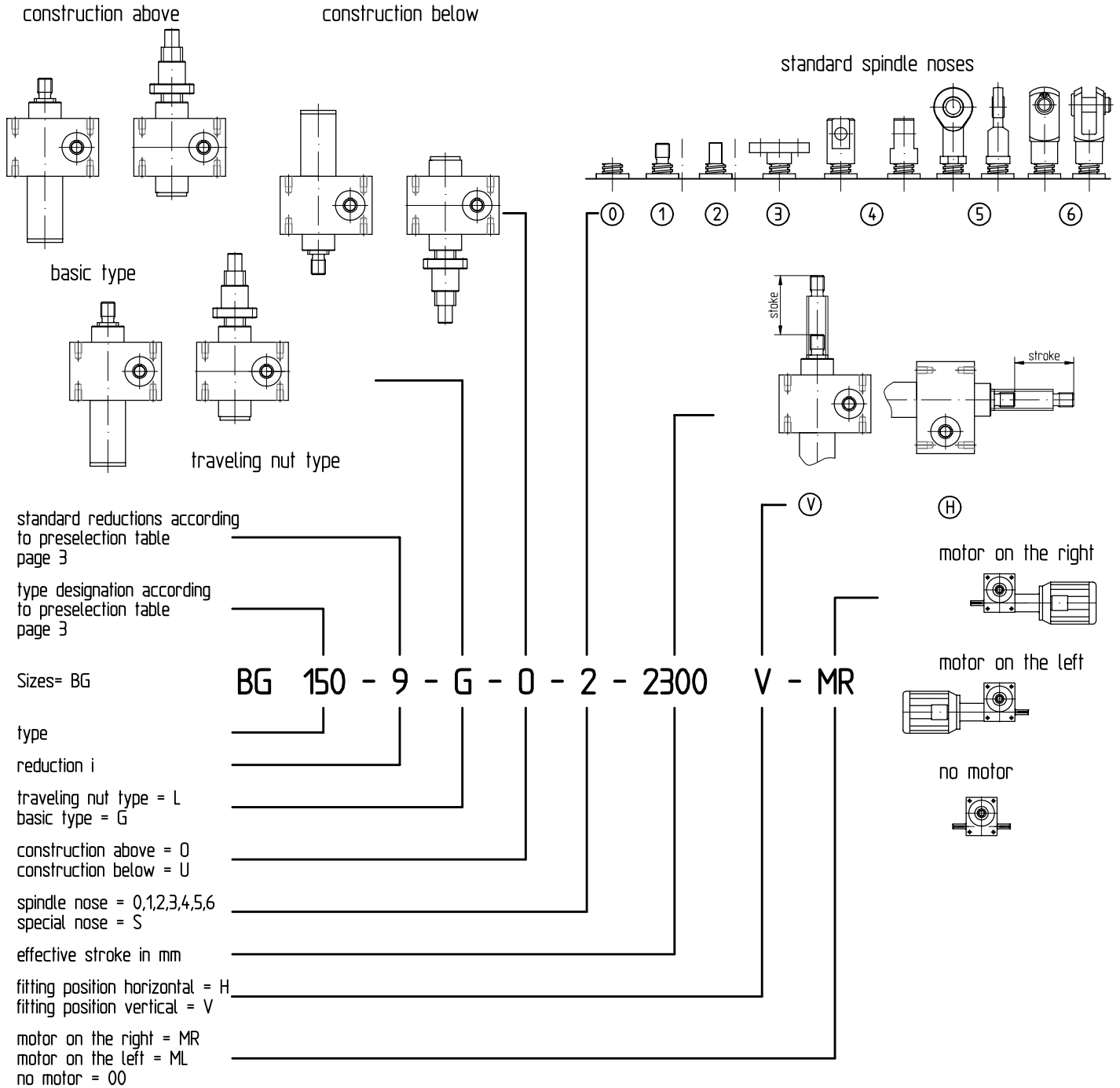

Above example for ordering:
 Sizes type 150, reduction 9:1, basic type construction up, spindle nose 2,
 stroke 2300mm, mounted vertical, with motor mounted on the right.

Additionally available options:

rigid protection
 expansion bellows
 spring steel spirals
 square locking device to prevent twisting

three-phase A.C. motor with or without brake
 d.c. motor
 gear motor
 limit stop

overload clutch
 ball bearing spindle
 cardanplate
 oil lubrication

The required options must be added to the order ID or marked in the questionnaire.

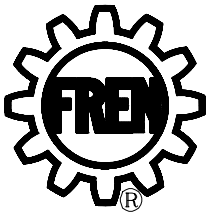

Spindle gear

Basic type (G)

ENZFELDER GMBH
Power transmission- and
lifting engineering

Eichengasse 36
A-2551 Enzesfeld-Lindabrunn
Tel.: ++43 (0) 2256 81287-0
Fax: ++43 (0) 2256 81287-95
E-Mail: office@enzfelder.at
Internet: www.enzfelder.at

sheet measure	Sizes/Types							
	Index	BG 2,5	BG 5	BG 10	BG 25	BG 50	BG 100	BG 150
		BG002,5_GA_?	BG005_GA_?	BG010_GA_?	BG025_GA_?	BG050_GA_?	BG100_GA_?	BG150_GA_?
	A	92	120	140	195	240	300	325
	A ₁	56	75	89	109	150	170	200
	B	60	80	100	130	180	200	210
	C	50	72	85	105	145	165	195
	D	38	52	63	81	115	131	155
	E	48	60	78	106	150	166	170
	F	21	24	27,5	45	47,5	67,5	65
	G	20	25	32	45	63	71	71
	H	14	18	20	36	36	56	56
	I	6	10	11	12	15	17	20
	J _{1/6}	9	10	14	16	20	25	25
	K	M6	M8	M8	M10	M12	M20	M24
	L ¹⁾	20/45	20/48/76 ⁴⁾	30/55/74 ⁴⁾	30/60	45/80	55/80	55/90
	N ₁	25	32	37	41	58,5	80	87,5
	N ₂	25	30	38	41	58,5	80	87,5
	O	18	24	28	31	39	46	49
	P	12	19	20	22	29	48	48
	Q	28	32	42	50	65	90	95
	Q ₁	30x30	35x35	40x40	50x50	65x65	90x90	100x100
	Q ₂ ³⁾	80	80	85	100	100	110	110
	R	M8	M12	M14	M20	M30	M36	M48x2
	S	50	62	75	82	117	160	175
	T ²⁾	27	35/48	45/49	50	65	95	95
	U ²⁾	12	12/25	18/22	23	32	40	40
	V ²⁾	26	30/48	39/57	46	60	85	90
	W	Tr 14x4	Tr 18x4	Tr 20x4	Tr 30x6	Tr 40x7	Tr 55x9	Tr 60x9
	W _{KGT}	-----	1605	2005	2505	4005/10	5010	-----
	Y	3	3	5	5	6	8	8
	Z	12	13	15	15	16	30	40
square locking device to prevent twisting								

1) The second measurement are for type with run off safty
 2) The second measurement are for type with ball bearing spindle
 3) The second measurement are for type with ball bearing spindle in construction below
 4) The measurement are for type with ball bearing spindle and run off safty in construction below
 Special executions on request are possible
 Subjects to measurements changes, representation not obligatory

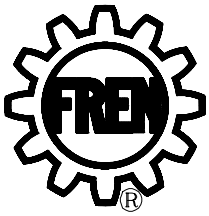

Spindle gear Traveling nut type (L)

ENZFELDER GMBH
Power transmission- and
lifting engineering
Eichengasse 36
A-2551 Enzesfeld-Lindabrunn
Tel.: ++43 (0) 2256 81287-0
Fax: ++43 (0) 2256 81287-95
E-Mail: office@enzfelder.at
Internet: www.enzfelder.at

sheet measure	Sizes/Types							
	Index	BG 2,5	BG 5	BG 10	BG 25	BG 50	BG 100	BG 150
		BG002,5_LA_?	BG005_LA_?	BG010_LA_?	BG025_LA_?	BG050_LA_?	BG100_LA_?	BG150_LA_?
	A	92	120	140	195	240	300	325
	A ₁	56	75	89	109	150	170	200
	B	60	80	100	130	180	200	210
	C	50	72	85	105	145	165	195
	D	38	52	63	81	115	131	155
	E	48	60	78	106	150	166	170
	F	21	24	27,5	45	47,5	67,5	65
	G	20	25	32	45	63	71	71
	H	14	18	20	36	36	56	56
	I	6	10	11	12	15	17	20
	J ₆	9	10	14	16	20	25	25
	K	M6	M8	M8	M10	M12	M20	M24
	L	69	95	112	134	185	232	244
	M ₁	24	28	32	38	63	72	85
	M ₂	44	48	55	62	95	110	125
	M ₃	34	38	45	50	78	90	105
	M ₄	25	44	44	46	73	97	99
	M ₅	10	12	12	14	16	18	20
	M ₆	6	6	7	7	9	11	11
	N ₁	25	32	37	41	58,5	80	87,5
	N ₂	25	30	38	41	58,5	80	87,5
	O	18	24	28	31	39	46	49
	P	12	15	20	25	30	45	55
	R ₆	8	12	15	20	25	40	45
	S	50	62	75	82	117	160	175
	U	12	12	18	23	32	40	40
V	26	30	39	46	60	85	90	
W ^{*)}	Tr 14x4	Tr 18x4	Tr 20x4	Tr 30x6	Tr 40x7	Tr 55x9	Tr 60x9	
X	10	12	15	20	25	25	25	
Y	3	3	5	5	6	8	8	
Z	12	13	15	15	16	30	40	

Special executions on request are possible
Subjects to measurements changes, representation not obligatory
*) Spindle also deliverable as ball-screw

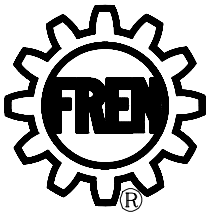

Spindle gear accessories

ENZFELDER GMBH
Power transmission- and
lifting engineering

Eichengasse 36
A-2551 Enzesfeld-Lindabrunn
Tel.: ++43 (0) 2256 81287-0
Fax: ++43 (0) 2256 81287-95
E-Mail: office@enzfelder.at
Internet: www.enzfelder.at

Flange plate (FP)

		measurement in mm								
Sizes		F ₁	F ₂	F ₃	F ₄	F ₅	F ₆	F ₇	F ₈	
BG 2,5	BG002,5_K3	50	40	26	M10	16	6	7	M4	
BG 5	BG005_K3	65	48	30	M12	20	7	9	M5	
BG 10	BG010_K3	80	60	39	M14	21	8	11	M6	
BG 25	BG025_K3	90	67	46	M20	23	10	11	M8	
BG 50	BG050_K3	110	85	60	M30	30	15	13	M8	
BG 100	BG100_K3	150	117	85	M36	50	20	17	M10	
BG 150	BG150_K3	170	130	90	M48x2	50	25	21	M10	

Spindle nose 4 (SE)

		measurement in mm						
Sizes		GK ₁	GK ₂	GK ₃	GK ₄	GK ₅	GK ₆	GK ₇ H8
BG 2,5	BG002,5_K4	40	30	12	10	25	M8	8
BG 5	BG005_K4	55	40	15	15	30	M12	10
BG 10	BG010_K4	63	45	20	18	40	M14	12
BG 25	BG025_K4	78	53	30	20	45	M20	16
BG 50	BG050_K4	100	70	35	30	60	M30	20
BG 100	BG100_K4	130	97	40	33	85	M36	22
BG 150	BG150_K4	120	75	60	45	90	M48x2	40

Pivoting head (GK)

		measurement in mm								
Baugröße		GK ₁	GK ₂	GK ₃	GK ₄	GK ₅	GK ₆	GK ₇	GK ₈	GK ₉
BG 2,5	BG002,5_K5	24	36	48	8	6	13	M8x1,25	12	8
BG 5	BG005_K5	34	50	67	10	8	18	M12x1,75	17,5	12
BG 10	BG010_K5	40	61	81	12	10	21	M14x2	20	15
BG 25	BG025_K5	53	77	103,5	16	13	32	M20x1,5	27,5	20
BG 50	BG050_K5	73	110	146,5	22	19	41	M30x2	37	30
BG 100	BG100_K5	82	125	166	25	21	50	M36x3	42	35
BG 150	BG150_K5	102	145	196	32	27	60	M42x3	52	45

Special executions on request are possible
Subjects to measurements changes, representation not obligatory

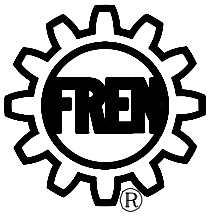

Spindle gear accessories

ENZFELDER GMBH
Power transmission- and
lifting engineering

Eichengasse 36
A-2551 Enzesfeld-Lindabrunn
Tel.: ++43 (0) 2256 81287-0
Fax: ++43 (0) 2256 81287-95
E-Mail: office@enzfelder.at
Internet: www.enzfelder.at

Fork head (GA)

Sizes		measurement in mm								
		GA1	GA2	GA3	GA4	GA5	GA6	GA7	GA8	GA9 H8
BG 2,5	BG002,5_K6	42	32	16	8	16	12	14	M8	8
BG 5	BG005_K6	62	48	24	12	24	18	20	M12	12
BG 10	BG010_K6	72	56	27	14	28	22,5	24	M14	14
BG 25	BG025_K6	105	80	40	20	40	30	34	M20	20
BG 50	BG050_K6	148	110	60	30	60	40	48	M30	30
BG 100	BG100_K6	188	144	72	36	72	54	60	M36	36
BG 150	BG150_K6	--	--	--	--	--	--	--	--	--

Fastening strips (BL)

Sizes		measurement in mm							
		B1	B2	B3	B4	B5	B6	B7	B8
BG 2,5	BG002,5_BL	90	75	12	10	7,5	6,5	38	50
BG 5	BG005_BL	120	100	20	10	10	8,5	52	72
BG 10	BG010_BL	140	120	20	10	10	8,5	63	85
BG 25	BG025_BL	170	150	25	12	10	11	81	105
BG 50	BG050_BL	230	204	30	16	13	13,5	115	145
BG 100	BG100_BL	270	236	40	25	17	22	131	171
BG 150	BG150_BL	290	250	50	30	20	26	155	205

Cardan plate (K)

Sizes		measurement in mm						K 90° turned	
		K1	K2	K3	K4	K5	K6	K4	K7
BG 2,5	BG002,5_KAR	50	60	15	70	10	38	80	32
BG 5	BG005_KAR	72	80	20	102	15	49	110	46
BG 10	BG010_KAR	85	100	25	125	20	60	140	60
BG 25	BG025_KAR	105	130	30	145	25	76	170	74
BG 50	BG050_KAR	145	180	40	205	35	102	240	108
BG 100	BG100_KAR	165	200	50	235	45	117	270	118
BG 150	BG150_KAR	195	210	60	275	50	120	290	130

Special executions on request are possible
Subjects to measurements changes, representation not obligatory

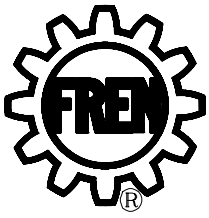

Spindle gear accessories

ENZFELDER GMBH
Power transmission- and lifting engineering

Eichengasse 36
A-2551 Enzesfeld-Lindabrunn
Tel.: ++43 (0) 2256 81287-0
Fax: ++43 (0) 2256 81287-95
E-Mail: office@enzfelder.at
Internet: www.enzfelder.at

Spindle gear with elastic coupling and motor

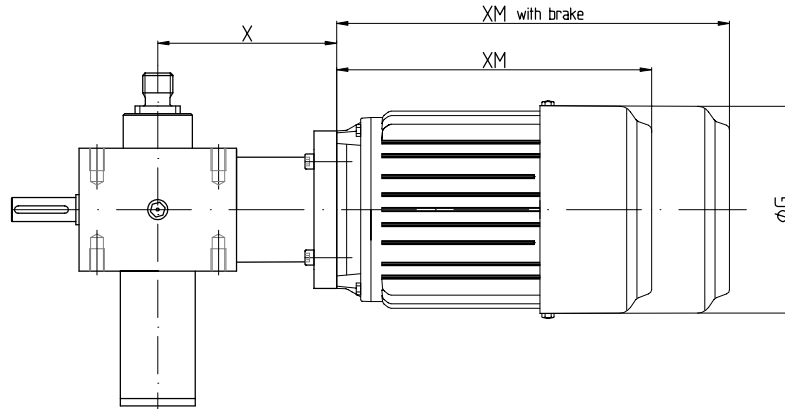

Sizes		motortype	IEC-flange			motor shaft	X	XM	XM with brake	ØG
			φA	φB	φE					
BG 2,5	BG002,5_Flan80	56	80	50	65	φ9x20	79,5	167	--	110
	BG002,5_Flan90	63	90	60	75	φ11x23	82,5	180	231	118
BG 5	BG005_Flan90	63	90	60	75	φ11x23	96,5	180	231	118
	BG005_Flan105	71	105	70	85	φ14x30	103,5	210	262	139
BG 10	BG010_Flan90	63	90	60	75	φ11x23	106,5	180	231	118
	BG010_Flan105	71	105	70	85	φ14x30	113,5	210	262	139
	BG010_Flan120	80	120	80	100	φ19x40	126,5	233	288	156
BG 25	BG025_Flan105	71	105	70	85	φ14x30	144	210	262	139
	BG025_Flan120	80	120	80	100	φ19x40	154	233	288	156
BG 50	BG050_Flan120	80	120	80	100	φ19x40	176,5	233	288	156
	BG050_Flan140	90	140	95	115	φ24x50	186,5	281	356	165
	BG050_Flan160	100	160	110	130	φ28x60	198,5	312	390	196
BG 100	BG100_Flan120	80	120	80	100	φ19x40	206,5	233	288	156
	BG100_Flan140	90	140	95	115	φ24x50	216,5	281	356	165
	BG100_Flan160	112	160	110	130	φ28x60	228,5	371	458	220
BG 150	BG150_Flan160	100	160	110	130	φ28x60	241	312	390	196
	BG150_Flan160	112	160	110	130	φ28x60	241	371	458	220
	BG150_Flan200	132	200	130	165	φ38x80	263	416	522	259

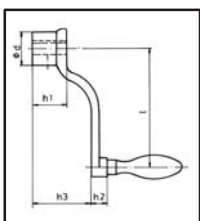

Crank handles

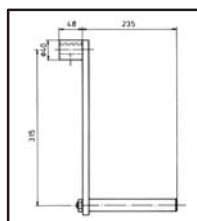

	Ch 1		
BG	5	10	25
a F 7	10	14	16
b P 9	3	5	5
c	11,4	16,3	18,3
d	28	38	38
h1	28	38	38
h2	13	14	14
h3	48	65	65
l	100	160	160

	Ch 2		
BG	50	100	150
a F 7	20	25	25
b P 9	6	8	8
c	22,8	27,3	28,3

Dimensional variations according to DIN 7168 medium. Deviating dimensions on request.

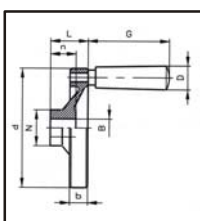

Hand wheels

type	d	N	b	n	L	G	D	Flut drill BH7	Weight KG
BG 5	80	26	13,0	16	30	58,5	22	10	0,16
BG 10	125	31	15,0	18	34	67,5	23	14	1,3
BG 25	160	36	18,0	20	37	67,5	23	14	1,5
BG 50, 100	200	42	20,5	24	45	80,0	26	18	1,0
BG 100, 150	250	48	23,0	28	51	90,0	28	24	1,3

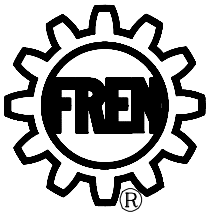

Spindle gear accessories

ENZFELDER GMBH
Power transmission- and lifting engineering
 Eichengasse 36
 A-2551 Enzesfeld-Lindabrunn
 Tel.: ++43 (0) 2256 81287-0
 Fax: ++43 (0) 2256 81287-95
 E-Mail: office@enzfelder.at
 Internet: www.enzfelder.at

Elastic couplings (KU)

Type R	Mt nom in Nm at 80° Shore ¹⁾	Mt nom in Nm at 92° Shore ²⁾	Mt nom in Nm at 98° Shore ³⁾	pilot drill min	hub 1 finished ϕd min	holes pilot drill max	hub 1a finished ϕd_1 min	holes pilot drill max	ϕA	ϕD	ϕD_1	L	l	E	s	b	M	ϕd_{11}	material	weight ³⁾ type 1 in kg	weight ³⁾ type 1a in kg	
14	4	7	12	-	4	14	-	-	30	30	-	35	11	13	1,5	10	-	10		0,14	0,14	
19/24	5	10	17	4	6	19	-	6	24	40	32	40	66	25	16	2	12	-	18		0,32	0,36
24/28	17	35	60	6	8	24	6	8	28	55	40	48	78	30	18	2	14	24	GG	0,60	0,72	
28/38	46	95	160	8	10	28	8	10	38	65	48	65	90	35	20	2,5	15	28	30		0,97	1,33
38/45	93	190	325	10	12	38	36	38	45	80	66	77	114	45	24	3	18	37	38	Alu order	2,08	2,46
42/55	130	265	450	12	14	42	40	42	55	95	75	94	126	50	26	3	20	40	46		3,21	3,93
48/60	150	310	525	13	15	48	46	48	60	105	85	102	140	56	28	3,5	21	45	51		4,41	5,19
55/70	180	375	625	18	20	55	52	55	70	120	98	120	160	65	30	4	22	52	60		6,64	8,10
65/75 ²⁾	205	425	640	20	22	65	63	65	75	135	115	135	185	75	35	4,5	26	61	68	GG	10,13	11,65
75/90 ²⁾	475	975	1465	28	30	75	73	75	90	160	135	160	210	85	40	5	30	69	80		16,03	19,43

¹⁾ The rated turning moments are valid for normal operation with slight jolts; due to the higher start-up moment of three-phase squirrel cage motors an impact factor of 2 must be taken into account.
²⁾ from size 65/75 95° Shore on
³⁾ weight for GG, aluminium approx. 60% less.

Product as delivered: enclosed

Finish-borings are made according to the ISO system of tolerances H7. Feather key grooves are made according to DIN 6885/1. The max. angle shift is 1°30', the twisting angle 3,2° at Mt nom. The operable temperature range lies between -40°C and +100°C.

Elastic propeller shafts G/GX/GZ

RPM - length - diagramm:
 Selection chart for sizes according to RPM and length of joint

size	rated torque [Nm]			weight [kg]		max. shift of angle		A	B	C	ϕD	d	d max	E	F	L_N	ϕN_2	R	T	T_x / M
	G	GX	GZ	for 2 hubs	for 1 m tube	G+GZ	GX													
1	10	10	10	1,0	1,1	3°	1°	24	7	5	56	8	25	22	2	24	36	30	1,5	$\phi 44 / 2 \times M6$
2	20	30	20	2,2	1,4	3°	1°	24	8	5	85	12	38	20	4	28	55	40	1,5	$\phi 68 / 2 \times M8$
4	40	60	40	3,4	1,6	3°	1°	28	8	5	100	15	45	24	4	30	65	45	1,5	$\phi 80 / 3 \times M8$
8	80	120	80	7,3	2,2	3°	1°	32	10	5	120	18	55	28	4	42	80	60	1,5	$\phi 100 / 3 \times M10$
16	160	240	160	12,4	2,5	3°	1°	42	12	5	150	20	70	36	6	50	100	70	1,5	$\phi 125 / 3 \times M12$
25	250	370	250	19,1	3,1	3°	1°	46	14	5	170	20	85	40	6	55	115	85	1,5	$\phi 140 / 3 \times M14$
30	400	550	400	31,1	4,8	3°	1°	58	16	5	200	25	100	50	8	66	140	100	1,5	$\phi 165 / 3 \times M16$
50	600	-	600	32,1	4,8	3°	1°	58	16	5	200	25	100	50	8	66	140	100	1,5	$\phi 165 / 3 \times M16$
90	900	-	900	58,7	7,6	3°	1°	70	19	5	260	30	110	62	8	80	160	125	2,0	$\phi 215 / 3 \times M20$

Special executions on request are possible
 Subjects to measurements changes, representation not obligatory

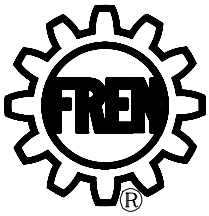

Spindle gear accessories

ENZFELDER GMBH
Power transmission- and lifting engineering
 Eichengasse 36
 A-2551 Enzesfeld-Lindabrunn
 Tel.: ++43 (0) 2256 81287-0
 Fax: ++43 (0) 2256 81287-95
 E-Mail: office@enzfelder.at
 Internet: www.enzfelder.at

Limit stop (EA)

type about

type below

	A	B	limit switch type	S1
BG2,5	32	stroke+80	current max. at voltage	250V 0,25A 120V 0,5A 24V 7A
BG5	32	stroke+80		
BG10	38	stroke+85		
BG25	42	stroke+100	type of connection	binding posts
BG50	52	stroke+100		
BG100	60	stroke+110		
BG150	60	stroke+110	setting range E	±15
temperature min/max				-10°C +80°C
system of protection				IP 65
type of switch				mech.

Limit switches must be adjusted in situ!
 Product as delivered: enclosed

Safety nuts

Connected with the loaded traveling nut via driving pins, the locking nut runs at idle. As the threads in the traveling nut wear it approaches the idling, unloaded and therefore unworn safety nut. The wear is ascertained by checking the slot H. When the table entry H has declined by half the traveling nut must be replaced!

The visual check of the slot H can be automated by integrating an automatic disconnecting limit switch which is actuated when the raveling nut sinks.

Standard sheet on request.
 Product as delivered: enclosed

Pedestal bearing

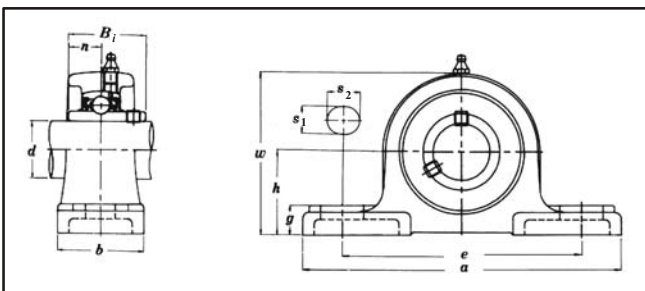

Typ	ø d (mm)	Dimensions (mm)									Bolt Used (mm)	Weight (kg)
		h	a	e	b	s ₂	s ₁	g	w	n		
UCP 205	25	36,5	140	105	38	19	13	13	71	14,3	10	0,8
UCP 206	30	42,9	165	121	48	21	17	15	84	15,9	14	1,3
UCP 207	35	47,6	167	127	48	21	17	16	93	17,5	14	1,6
UCP 208	40	49,2	184	137	54	21	17	17	98	19,0	14	2,0
UCP 209	45	54,0	190	146	54	21	17	17	106	19,0	14	2,2
UCP 210	50	57,2	206	159	60	22	20	19	113	19,0	16	2,9
UCP 212	60	69,8	241	184	70	25	20	22	138	25,4	16	4,9
UCP 214	70	79,4	266	210	72	30	25	28	156	30,2	20	6,8
UCP 216	80	88,9	292	232	78	35	25	32	174	33,3	20	9,0
UCP 217	85	95,2	310	247	83	40	25	32	185	34,1	20	10,8

Special executions on request are possible
 Subjects to measurements changes, representation not obligatory

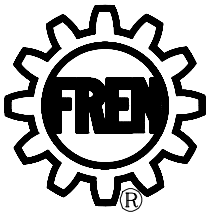

Mounting and Maintenance Instructions for Spindle gear BG2,5 - BG150

ENZFELDER GMBH
Power transmission- and
lifting engineering
Eichengasse 36
A-2551 Enzesfeld-Lindabrunn
Tel.: ++43 (0) 2256 81287-0
Fax: ++43 (0) 2256 81287-95
E-Mail: office@enzfelder.at
Internet: www.enzfelder.at

Mounting

Spindle gears must be mounted in true alignment on a flat surface which must be so stiff that it can assume the maximal load without oscillations or deformations. The alignment and correct positioning of the spindle gear must be done very carefully as no side forces should act on spindle and guide rings.

In lifting systems the spindle noses (in case of the basic type) or the traveling nuts (in case of the traveling nut type) must lie level with each other before the worms of the spindle gears are connected.

Before the driving gear is mounted the sense of rotation must be checked: in bevel gear driven lifting systems the sense of rotation can easily be confused; the result would be faulty mounting and possible damage of the installation.

Before putting it into service the spindle gear or the lifting system should be turned by hand once. If this requires non uniform forces the spindles are misaligned both to each other and to the installation. Adjustments are necessary; the fastening screws must be worked loose and the whole lifting gear must again be turned by hand. Spindles must be lubricated before being put into service; they are delivered non-greased!

Oil-lubricated worm gears: the upper screwed sealing plug must be replaced by the vent screw provided.

Attention! Misalignment and faulty gripping lead to increased power consumption, which is converted into friction and noise. The consequence is quick wear.
Additional add-on pieces: check under "Options".

If our specifications and performances according to the technical instructions are not observed and/or the components are not used as prescribed, any warranty claims will no longer be applicable.

Maintenance

Greases spindle and worm gear via lubricating nipple at regular intervals (~30-50 operating hours), clean and lubricate the spindle at the same time. The intervals depend on the given operating conditions and the duty cycle of the spindle gears. In case doubt please set up the lubrication plan together with us. The use of spindle spray increases the working life of the spindle and spindle nut. After approx. 200-300 operating hours the wear of the traveling nut or the worm wheel due to the backlash of threads should be checked. The maximal normal backlash of single trapezoid threads must not exceed 1/4 of the thread pitch. In the cases of multiple threads or special threads 1/4 of P is the maximum normal acceptable backlash. When the maximum normal backlash is reached the traveling nut or the worm wheel must be replaced. After a short run-in period all screws must be checked.

After approx. 500 operating hours we recommend cleaning gear and spindle to remove the grease, checking all piece parts as to wear, and recharging them with new grease.

Recommended lubricants: Shell Darina 2, Castrol Grease MS3, BP Energrease LS-EP2.

The lubricant recommended can be used both for gears and spindles. If a high-grade spindle lubricant is to be used, we recommend Klueberplex GE 11-680.

For special conditions (e.g. higher temperatures) we recommend the lubricants specified in the enclosed technical manual.

In case of possible dirt accumulation in or damage of the spindle, expansion bellows or spring steel spirals must be used to protect the spindle. For oil-lubricated gears please ask for a special service manual.

If you order spare parts the gear specifications marked on the type plate must be provided.

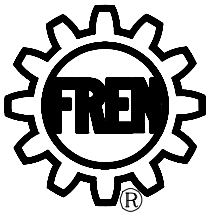

Critical compressive force

ENZFELDER GMBH
Power transmission- and
lifting engineering

Eichengasse 36
A-2551 Enzesfeld-Lindabrunn
Tel.: ++43 (0) 2256 81287-0
Fax: ++43 (0) 2256 81287-95
E-Mail: office@enzfelder.at
Internet: www.enzfelder.at

Slender spindles subjected to compression are liable to buckle laterally. Before defining the permissible compressive force acting on the spindle the safety factors applying to the lifting equipment must be taken into account.

F (kN) = axial force

f_k = correction facto taking into account type of spindle bearing arrangement

F_{krit} (kN) = critical compressive force depending on free length L.

s = safety factor depends one use usual values between 3 and 6

$$F \leq f_k \times F_{krit} \times \frac{1}{s}$$

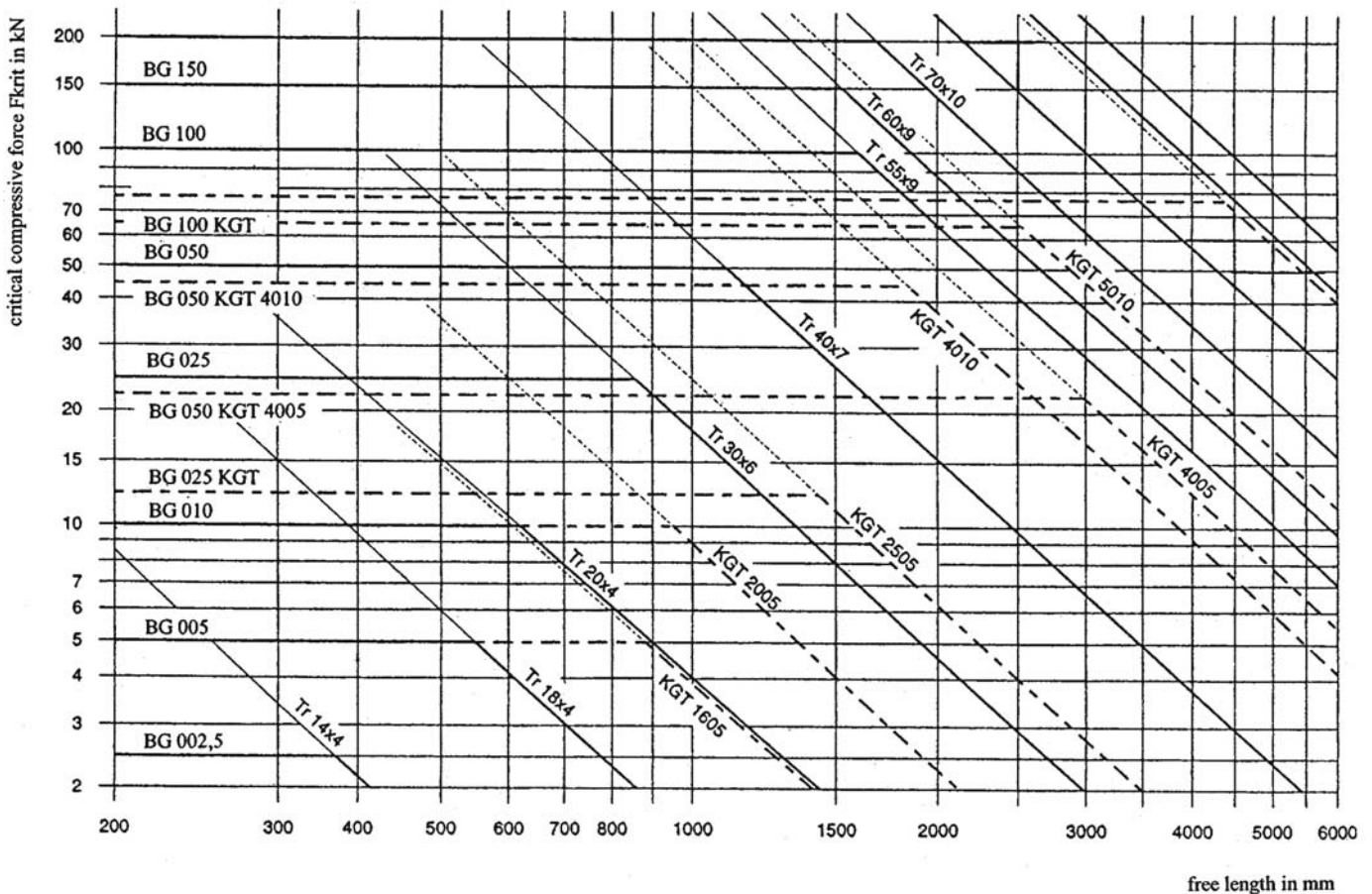
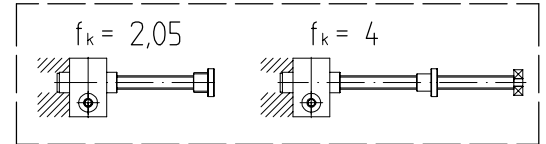
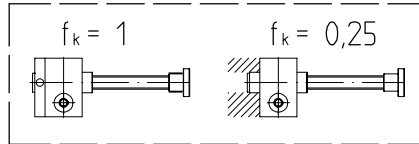



Additional forces acting on the spindle gear

ENZFELDER GMBH
Power transmission- and lifting engineering
 Eichengasse 36
 A-2551 Enzesfeld-Lindabrunn
 Tel.: ++43 (0) 2256 81287-0
 Fax: ++43 (0) 2256 81287-95
 E-Mail: office@enzfelder.at
 Internet: www.enzfelder.at

Lateral forces

When determining the lateral force acting on the spindle, possible forces resulting from the spindle moment M_{sp} and, if the spindle is mounted horizontally, the dead weight must be taken into account. The diagram below illustrates the maximum permissible lateral force F_s depending on the free spindle length without any additional lateral guide.

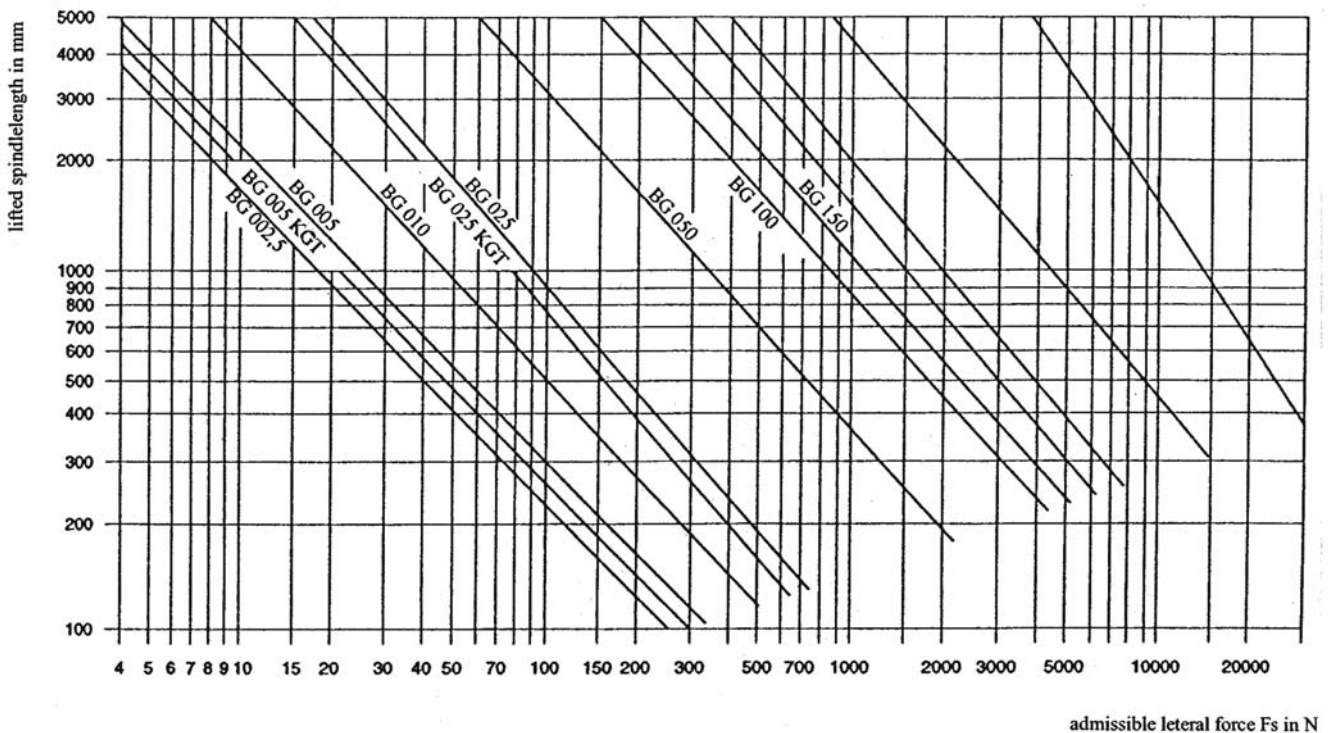

Spindle torque

The Spindle torque M_{sp} is the torque acting on the various parts of the equipment via the spindle ends 3,4,6 or the running nut. The spindle torque can be calculated using the factor f_M in the table below.

F (kN) = axial force

f_M = conversion factor including screw geometry and friction.

M (Nm) = torque of the elevating screw

The lower value applies under normal lubrication conditions, the higher value in case of dry friction and static friction.

$$F \times f_M = M_{sp}$$

	BG 2,5	BG 5	BG 10	BG 25	BG 50	BG 100	BG 150
f_M	1,1.....2,6	1,5.....3,1	1,6.....3,4	2,4.....5,1	3,0.....6,8	4,0.....9,3	4,3.....10,1

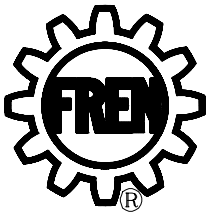

Additional forces acting on the spindle gear

ENZFELDER GMBH
Power transmission- and
lifting engineering

Eichengasse 36
A-2551 Enzesfeld-Lindabrunn
Tel.: ++43 (0) 2256 81287-0
Fax: ++43 (0) 2256 81287-95
E-Mail: office@enzfelder.at
Internet: www.enzfelder.at

Maximum driving torque

If the spindle gear is locking due to an obstacle, the maximum torques illustrated in Table 1 can still be picked up by the toothing at the transmission shaft.

In elevating equipment with serial spindle elevating gears the spindle gear next to the drive can transmit this moment via the transmission shaft.

	BG 2,5	BG 5	BG 10	BG 25	BG 50	BG 100	BG 150
$M_{T \max}$ (Nm)	1,5	3,4	7,1	18	38	93	148

Tab. 1

Forces and moments acting on the transmission shaft

If the spindle gears are driven via belts or chains, care must be taken to ensure that the arising thrust force is kept at a tolerable level. This thrust force is caused by the fact that the equipment is driven via a clutch not free from lateral force.

In this case Table 2 applies

In the worst case quick wear may occur, due to bending of the worm shaft the worm may be lifted from the worm wheel, which must be avoided.

	BG 2,5	BG 5	BG 10	BG 25	BG 50	BG 100	BG 150
$F_{r \max}$ (kN)	0,07	0,1	0,2	0,3	0,5	0,8	0,8

Tab. 2

Required speed of the driving motor

The required speed of the driving motor is calculated from the proposed elevating speed, spindle gear ratio and the gear ratio of the transmission elements (e.g. bevel gears).

There may be several possibilities to reach a specific elevating speed.

Choosing the driving motor

By determining the driving torque and choosing the speed the driving motor can be defined.

After choosing the driving motor the elevating equipment must be tested to avoid overload of the spindle gears or the transmission elements.

In elevating equipment with several spindle lifting gears uneven loading of the individual spindle gears may lead to overstrain.

To avoid this, elevating equipment should be protected with safety switches or torque-limited clutches.

Also, spindle gears should not be subjected to excessive vibration because the function of the automatic lock may no longer be guaranteed in such case. To avoid accidents brakes or brake motors should be integrated in the elevating equipment.



Additional forces acting on the spindle gear

ENZFELDER GMBH
Power transmission- and lifting engineering

Eichengasse 36
A-2551 Enzesfeld-Lindabrunn
Tel.: ++43 (0) 2256 81287-0
Fax: ++43 (0) 2256 81287-95
E-Mail: office@enzfelder.at
Internet: www.enzfelder.at

Required driving torque of a spindle gear

The required driving torque of a spindle gear is calculated from the axial load resting on the spindle, the transmission and the efficiency. Please bear in mind that the starting moment may be higher than the moment required during operation.

This applies particularly to spindle gears after a long standstill and to low-efficiency gears.

Required driving torque of spindle elevating equipment

The required driving torque of spindle elevating equipment is calculated from the driving torques of the individual spindle gears, taking the arising friction losses in the transmission elements (clutches, propeller shaft, bevel gears,...) into account.

It is helpful illustrate the flux of forces in a sketch.

- F (kN) = axial force
- M_T (Nm) = required driving torque of the spindle lifting gear at the driving shaft
- M_0 (Nm) = idle moment of the spindle lifting gears only a mean value, determined empirically
- η = efficiency of the spindle lifting gear only a mean value
- $\frac{P}{I}$ = transmission of the spindle lifting gear in mm elevation/revolution of the driving shaft

$$M_T = \frac{F}{2 \times \pi \times \eta_{G1}} \times \frac{P}{I} + M_0$$

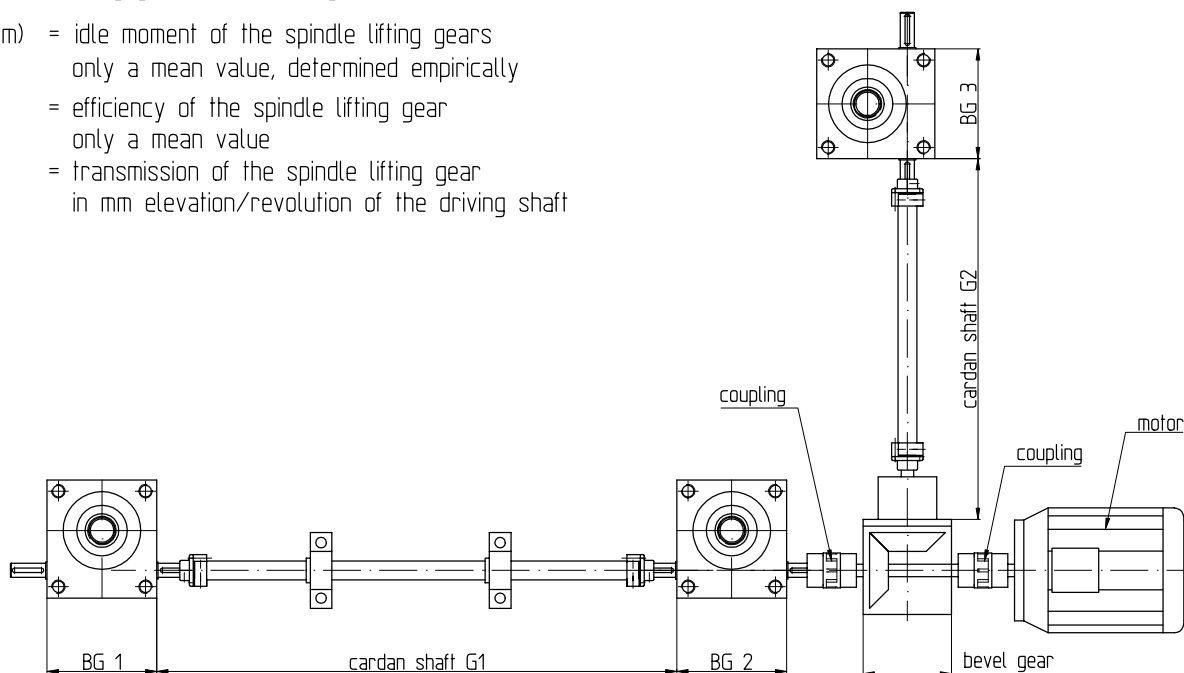

$$M_{\text{driving motor}} = M_{T \text{ BG1}} \times \frac{1}{\eta_{G1}} + M_{T \text{ BG2}} + M_{T \text{ BG3}} \times \frac{1}{\eta_{G2}} \times \frac{1}{\eta_K}$$

$M_{T \text{ BG1}}$ = required driving torque spindle gear

η_{G1} = efficiency cardan shaft G1. Value around 0,75 to 0,95 depending on the number of pedestal bearings

η_K = efficiency bevel gear (only in case of flux via toothing, here between cardan shaft G1 and motor) value around 0,9

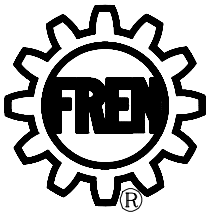

Questionnaire

ENZFELDER GMBH
Power transmission- and
lifting engineering

Eichengasse 36
A-2551 Enzesfeld-Lindabrunn
Tel.: ++43 (0) 2256 81287-0
Fax: ++43 (0) 2256 81287-95
E-Mail: office@enzfelder.at
Internet: www.enzfelder.at

COMPANY.....
ADDRESS.....
NAME..... Dept..... Phone..... Fax.....

To be able to prepare a proposal meeting your specific demands, please provide us with the following information:

In which systems are the lifting elements to be used?

.....
Number of systems.....
Number of lifting elements per system.....

AXIAL LOAD

per system pressure dynamic..... kN tension dynamic..... kN
static..... kN static..... kN
per spindle pressure dynamic..... kN tension dynamic..... kN
static..... kN static..... kN

Type of buckling load according to Euler I , II , III oder IV

OPERATING CONDITIONS

Effective stroke..... mm
Side forces acting..... kN
Lifting speed desired..... mm/min
Mounting of spindle..... vertically/horizontally
Ambient temperature..... °C
Duty cycle/load conditions per 10min.....
per hour.....
Distance per alternation of load..... mm

FOR WHICH PARTS DO YOU WISH TO RECEIVE OUR OFFER?

Spindle lifting element with lifting spindle:

Basic type..... 0 oder U
Spindle nose..... 0/1/2/3/4/5/6

Spindle lifting element with rotating spindle and traveling nut:

Travling nut type..... 0 oder U
Spindle nose..... 0/1/2

Expansion bellows..... yes/no
Bevel gear box..... yes/no
Elastic cardan shafts..... yes/no
Couplings..... yes/no
Pedestal bearings..... yes/no
Motor; voltage..... frequency..... system of protection.....
Limit stop..... yes/no
Crank handle, handwheel..... yes/no
Fastening strips..... yes/no
Cardan plate..... yes/no
Safety nut..... yes/no
Other.....



Examples for arrangements

ENZFELDER GMBH
Power transmission- and
lifting engineering

Eichengasse 36
A-2551 Enzesfeld-Lindabrunn
Tel.: ++43 (0) 2256 81287-0
Fax: ++43 (0) 2256 81287-95
E-Mail: office@enzfelder.at
Internet: www.enzfelder.at

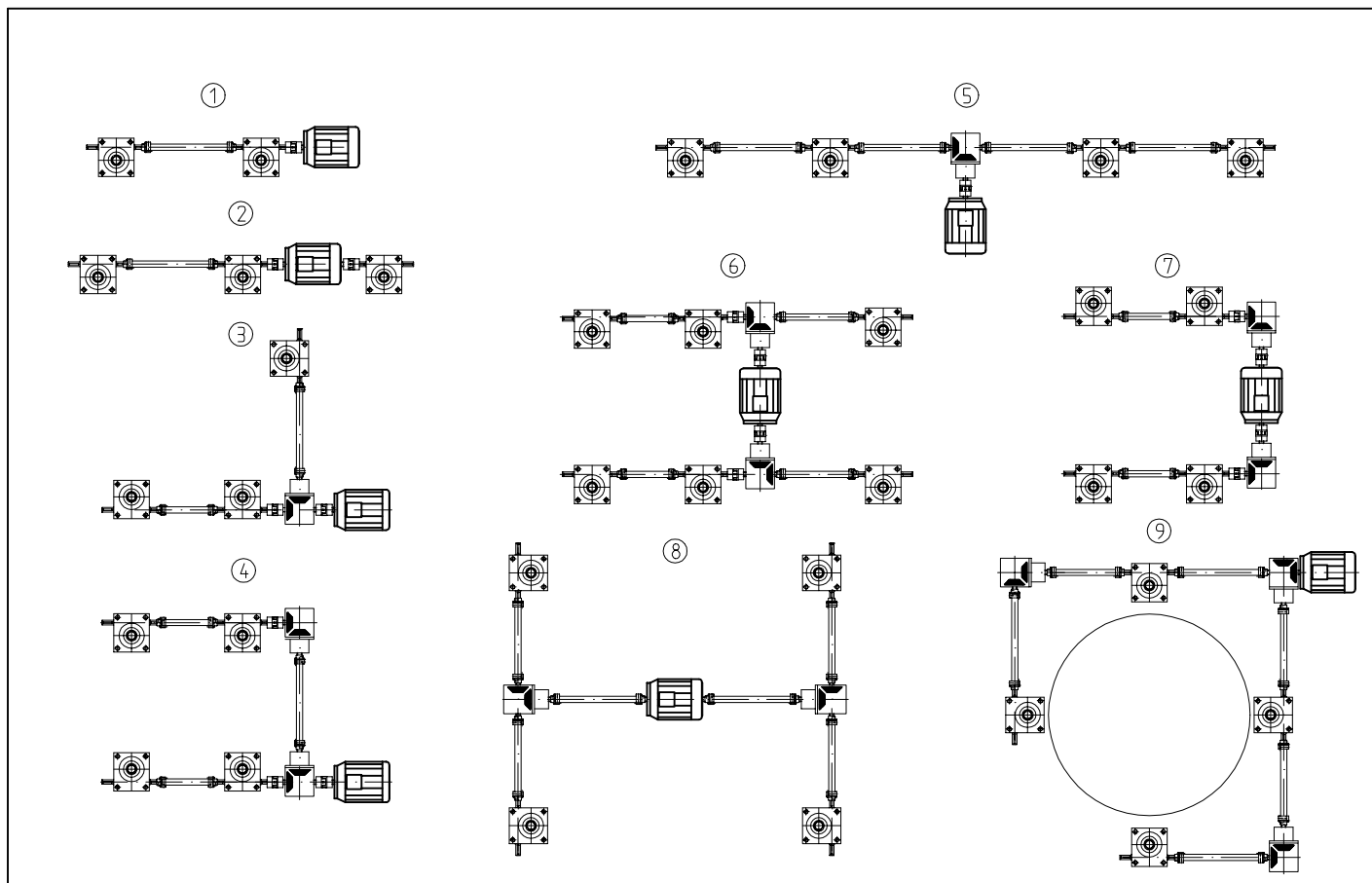

Please provide us with a sketch on the desired arrangement as shown above or according to your own ideas.
Please enter the distance from spindle to spindle and possibly lateral guidings into the sketch.
If you wish to receive an offer on spindle lifting elements actuated by multi-thread spindles or ball screw spindles,
or if stainless material is desired, please let us know, too.

Sketch

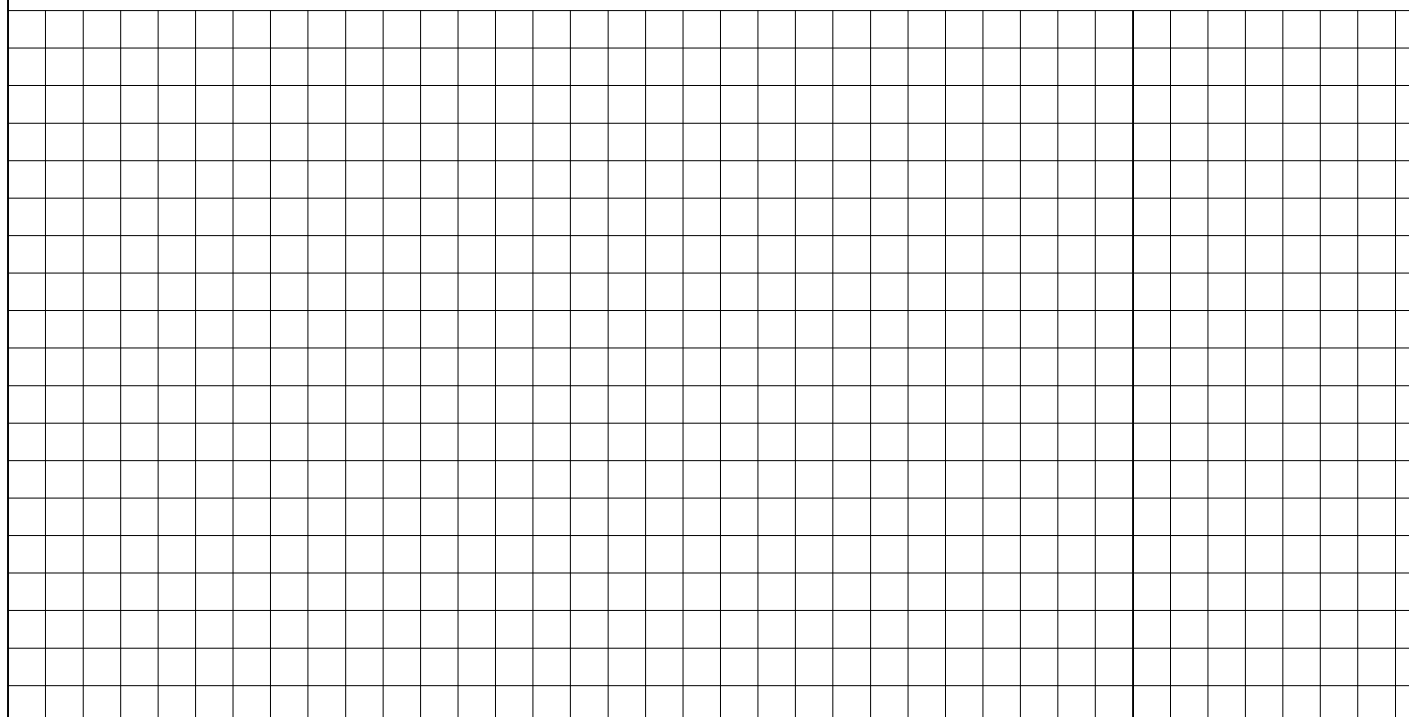

Delivery programm

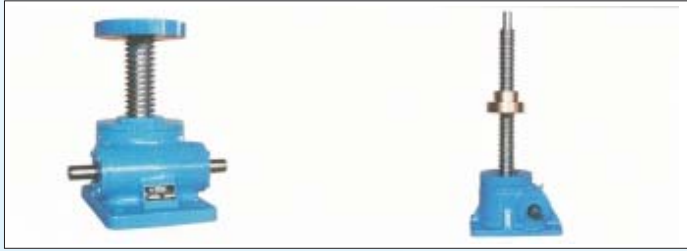

FREN Spindle gear for lifting, lowering, pulling, pushing, sluing, or rotating
Forces up to 3000kN
Lifts up to 10000mm

FREN Electric cylinders for lifting, lowering, pulling, pushing, sluing, or rotation
Forces up to 1000kN
Lifts up to 2500mm



FREN Bevel gears 'K' and Bevel gears cubic 'H' for deflecting input shafts
Speeds up to 6500U/min
Torques up to 5200Nm

FREN Resilient cardan shafts for transmitting torques with assembling inaccuracies
Angles up to 3°
Torques up to 500Nm



FREN Telescopic gears and telescopic cylinders for lifting, lowering, pulling, pushing
Forces up to 1000kN
Lifts up to 10000mm

FREN Planet gears in special designs for reducing speeds and increasing torques
Gear reduction 1,5:1 up to 1500:1
Torques up to 1000Nm



FREN Scissor-type lifting platforms for lifting and lowering including a wide range of accessories
Forces up to 500kN
Lifts up to 5000mm

FREN Cable winches for lifting, lowering, pulling or sluing
Forces up to 300kN
Lifts up to 100000mm

